

# G913

Wireless RGB Mechanical Gaming Keyboard

无线 RGB 机械游戏键盘

무선 RGB 기계식 게임 키보드

無線 RGB 機械式遊戲鍵盤



logitech 

# CONTENTS

English . . . . .	3	한국어 . . . . .	27
简体中文 . . . . .	15	繁體中文 . . . . .	39

## LIGHTSPEED CONNECTION

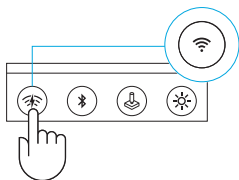
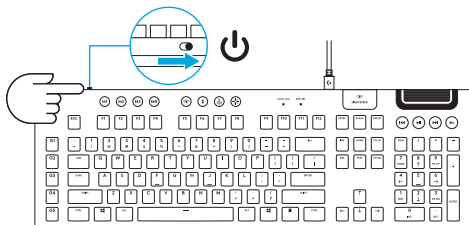
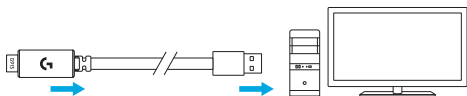

[www.logitech.com/support/G913](http://www.logitech.com/support/G913)

## BLUETOOTH® CONNECTION

1

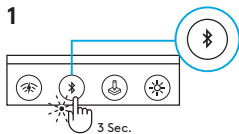

2



3



4

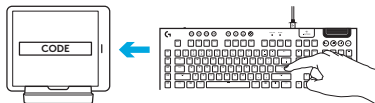

# CHARGING

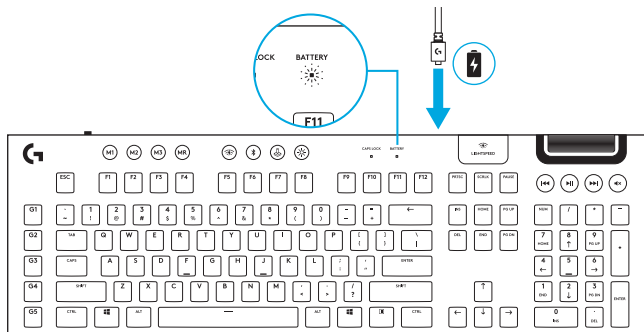

## KEYBOARD FEATURES

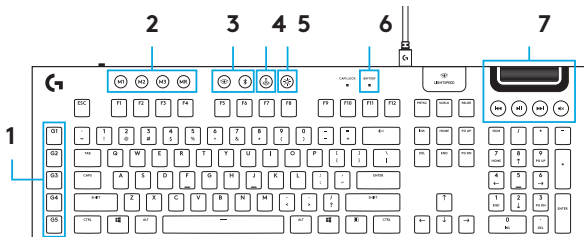

1. G-Keys
2. Mode Switches
3. LIGHTSPEED and *Bluetooth*
4. Game Mode
5. Brightness
6. Battery Light
7. Media Controls

## KEYBOARD FEATURES — LIGHTING FUNCTIONS

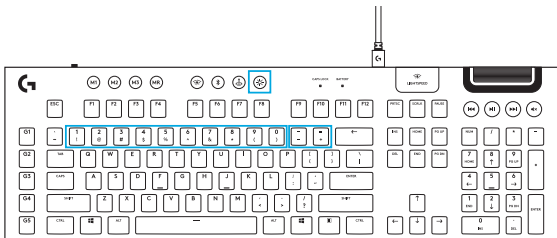

In addition to the lighting features available through G HUB software, G913 has onboard lighting effects. To select these effects, press and hold the Brightness button while pressing the keyboard number keys to select an effect:

- **Brightness + key 1:** Colorwave (left to right)
- **Brightness + key 2:** Colorwave (right to left)
- **Brightness + key 3:** Colorwave (center out)
- **Brightness + key 4:** Colorwave (bottom up)
- **Brightness + key 5:** Color cycle
- **Brightness + key 6:** Ripple
- **Brightness + key 7:** Breathing
- **Brightness + key 8:** User-stored lighting
- **Brightness + key 9:** User-stored lighting
- **Brightness + key 0:** Cyan blue
- **Brightness + key -:** Decreases effect speed
- **Brightness + key +:** Increased effect speed

User-stored effects are saved to the keyboard by G HUB software.

## KEYBOARD FEATURES — G-KEYS

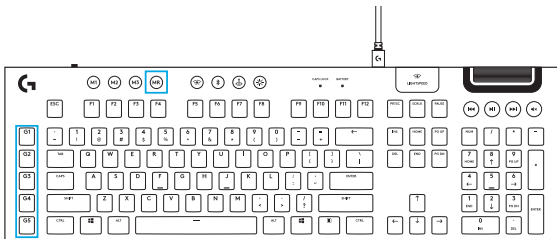

- 5 programmable G-keys and three M-keys provide up to 15 unique functions per game.
- Customize the G-keys using Logitech G HUB Software.
- To record a macro:
  1. Press the MR key
  2. Press a G-key.
  3. Type the keys to be recorded.
  4. Press the MR key.
    - To record a second macro to the same G-key, press M2 and repeat steps 1-4.
    - For a third macro, press M3 and repeat steps 1-4.

Download and install Logitech G HUB software from [logitechG.com/GHUB](https://logitechG.com/GHUB)



## GAME MODE BUTTON



This button disables the standard Windows key and Menu key to prevent the Windows Start menu from activating during a game, which might disrupt play. The game mode LED is lit during game mode.

## KEYBOARD BACK — LIGHTING



Adjust keyboard brightness by cycling the keyboard brightness button.

## ONBOARD MEMORY



Three onboard profiles can be saved to G913. The profiles are downloaded into the G913 through G HUB software, and are accessed by selecting M1, M2, or M3 when the keyboard is in Onboard mode (selected from G HUB software, or when G HUB software is off or not installed).

## KEYBOARD FEATURES — MEDIA CONTROLS

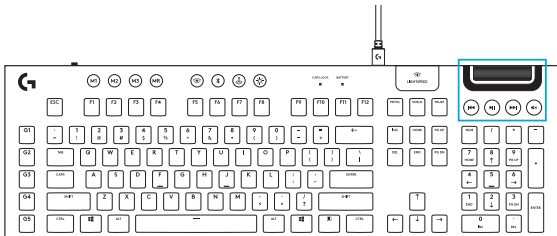

G913 has media controls, located in the upper right corner of the keyboard.

- Volume roller — controls volume of the active audio on your PC.
- Skip back — goes to the beginning of a track, or to a previous track, depending on the application.
- Play/Pause — starts or stops the audio or video source playback.
- Skip forward — goes to the end of the track or to the next track, depending on the application.
- Mute — stops audio output.

## KEYBOARD FEATURES — BATTERY INDICATOR

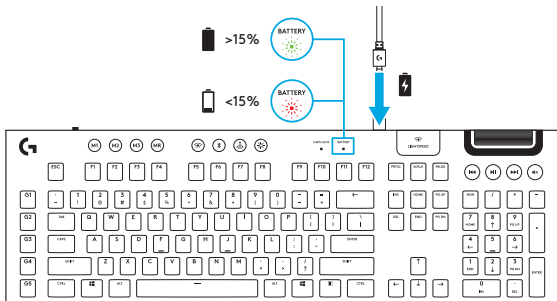

- Pulsed green when charging.
- Shows green momentarily when started when battery is above 15%.
- Shows red when keyboard needs charging.

## KEYBOARD FEATURES — WIRELESS CONTROLS

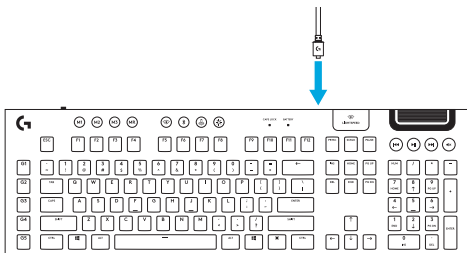
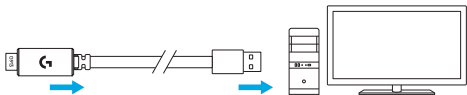

- LIGHTSPEED button selects LIGHTSPEED wireless connection, which connects to the PC or Mac using the included receiver dongle. It shows white when connected, blue when wired connection.

## KEYBOARD FEATURES — *BLUETOOTH*<sup>®</sup>

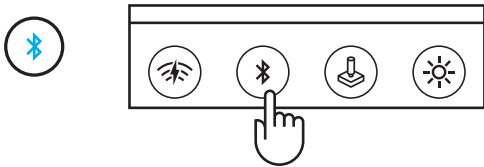

- *Bluetooth* button connects to devices via a *Bluetooth* connection. It shows blue when connected.

## KEY CAP REMOVAL + REPLACEMENT

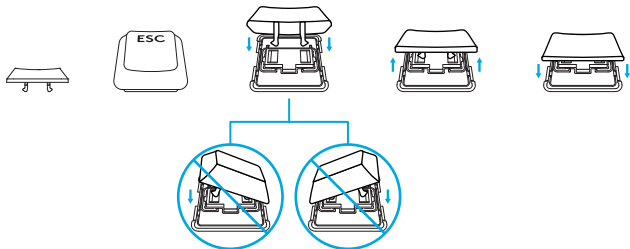

## CARE AND CLEANING

To clean the keyboard, use a soft, lint-free or microfiber cloth. A damp cloth can be used. Do not use harsh cleaning solutions.

Do not immerse the keyboard or expose it to liquids.

## LIGHTSPEED 连接

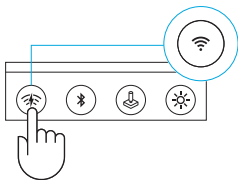
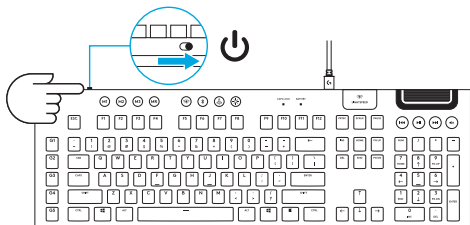
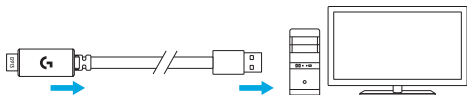

[www.logitech.com/support/G913](http://www.logitech.com/support/G913)

## 蓝牙™ 连接

1

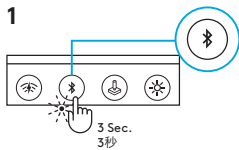

2



3



4

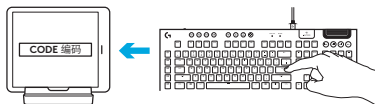



# 充电

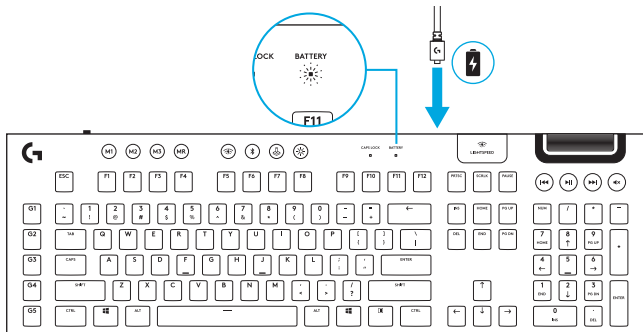

## 键盘特性

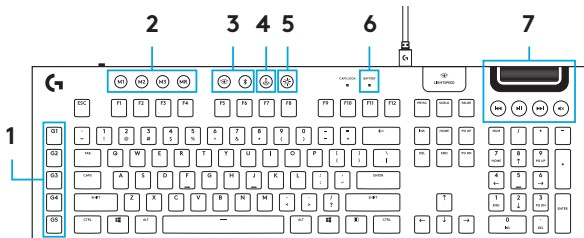

1. G 键
2. 模式切换开关
3. LIGHTSPEED 和 蓝牙
4. 游戏模式
5. 亮度
6. 电量指示灯
7. 媒体控制

## 键盘特性 - 灯光功能

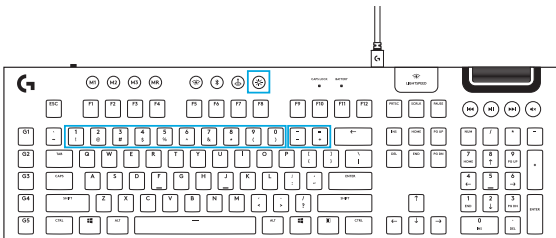

除了通过 G HUB 软件提供的灯光功能外, G913 还具有板载灯光效果。欲选择板载效果, 请在按住键盘数字键的同时按住亮度按钮以选择效果:

- 亮度 + 1 键: 色彩波浪 (从左至右)
- 亮度 + 2 键: 色彩波浪 (从右至左)
- 亮度 + 3 键: 色彩波浪 (从中间向外扩散)
- 亮度 + 4 键: 色彩波浪 (自下而上)
- 亮度 + 5 键: 色彩循环
- 亮度 + 6 键: 涟漪
- 亮度 + 7 键: 呼吸灯
- 亮度 + 8 键: 用户存储的光效
- 亮度 + 9 键: 用户存储的光效
- 亮度 + 0 键: 青蓝色
- 亮度 + - 键: 降低光效速度
- 亮度 + + 键: 提高光效速度

用户存储的光效通过 G HUB 软件保存至键盘。

## 键盘特性 - G 键

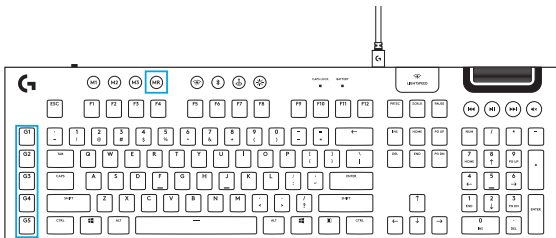

- 5 个可编程 G 键和三个 M 键，可为每个游戏提供多达 15 种不同的功能。
- 使用罗技 G HUB 软件自定义 G 键。
- 欲录制宏：
  1. 按下 MR 键
  2. 按下一个 G 键。
  3. 按下欲录制的按键。
  4. 按下 MR 键。
    - 欲为同一个 G 键录制第二个宏，按下 M2 并重复第 1-4 步。
    - 欲录制第三个宏，按下 M3 并重复第 1-4 步。

下载并安装罗技 G HUB 软件请访问 [logitechG.com/GHUB](http://logitechG.com/GHUB)。

## 游戏模式按钮



此按钮将禁用标准的 Windows 键和菜单键，防止在游戏中激活 Windows 开始菜单，避免游戏中断。游戏模式 LED 指示灯在游戏模式期间将亮起。

## 键盘背光



通过键盘亮度按钮循环调节键盘亮度。

## 板载内存



G913 可保存三个板载配置文件。通过 G HUB 软件将配置文件下载至 G913，当键盘处于板载模式时（从 G HUB 软件中选择，或者当 G HUB 软件关闭或未安装时），可选择 M1、M2 或 M3 启用这些配置文件。

## 键盘特性 - 媒体控制

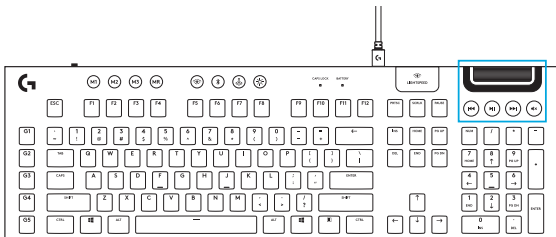

G913 具有媒体控制按钮，位于键盘右上部。

- 音量滚轮 - 控制 PC 正播放音频的音量。
- 后退 - 根据应用程序的不同，可跳转至此音轨的开始或前一个音轨。
- 播放/暂停 - 开始或停止音频或视频播放。
- 前进 - 根据应用程序的不同，可跳转至此音轨的结尾或下一个音轨。
- 静音 - 停止音频输出。

## 键盘特性 - 电量指示灯

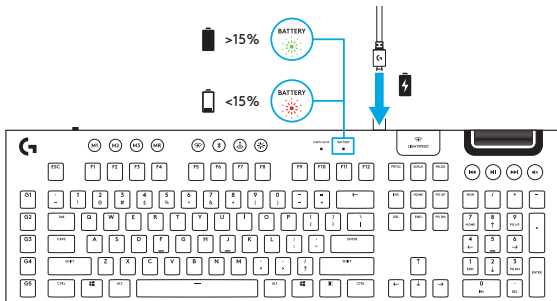

- 充电时闪烁绿色。
- 当电量高于 15% 时，启动时会短暂显示绿色。
- 当键盘需要充电时显示红色。

## 键盘特性 - 无线控制

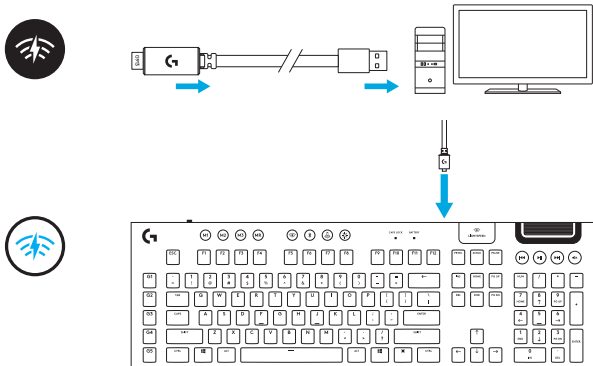

- LIGHTSPEED 按钮可选择 LIGHTSPEED 无线连接, 即通过随附的无线接收器连接 PC 或 Mac。连接时亮起白色, 有线连接时亮起蓝色。



## 键盘特性 - 蓝牙

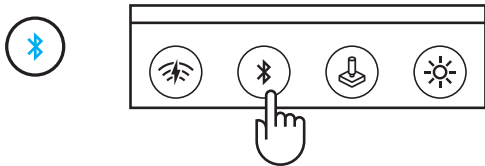

- 蓝牙按钮可通过蓝牙连接到设备。连接时显示蓝色。

## 键帽移除 + 替换

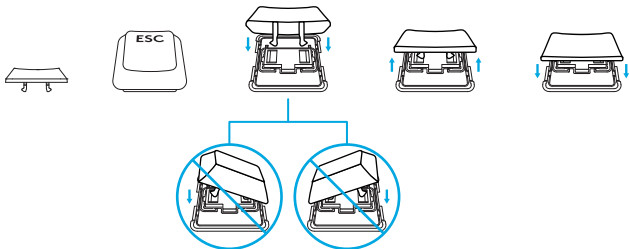

## 保养和清洁

欲清洁键盘，请使用柔软的无绒或超细纤维布。可以使用湿布。请勿使用刺激性清洁剂。请勿将键盘浸入水中或将其暴露在液体中。

## LIGHTSPEED 연결

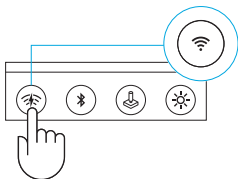
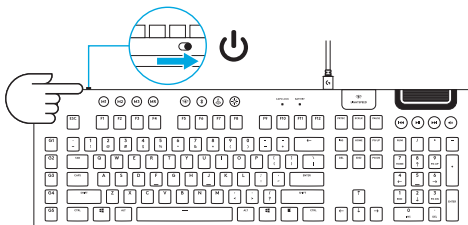
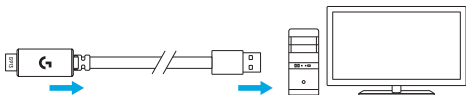

[www.logitech.com/support/G913](http://www.logitech.com/support/G913)

## BLUETOOTH® 연결

1

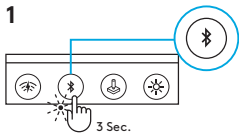

2



3



4

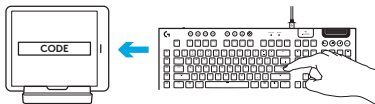

## 충전 중

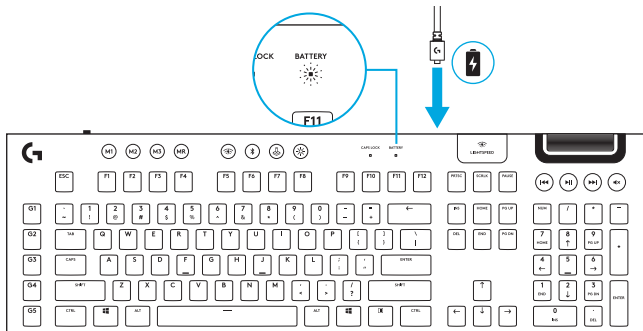

## 키보드 기능

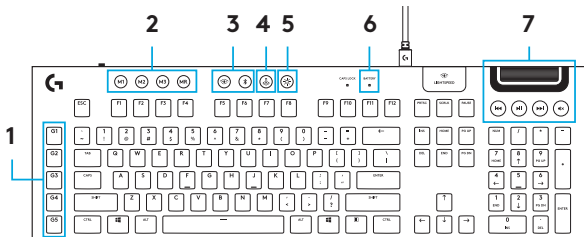

1. G 키
2. 모드 스위치
3. LIGHTSPEED 및 *Bluetooth*
4. 게임 모드
5. 밝기
6. 배터리 표시등
7. 미디어 컨트롤

## 키보드 기능 – 조명 기능

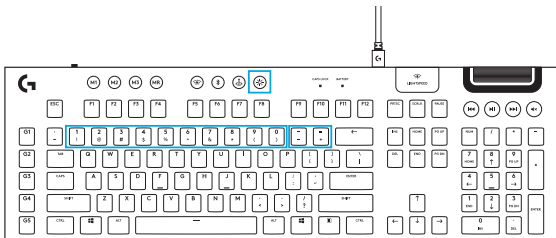

G913는 G HUB 소프트웨어를 통해 사용할 수 있는 조명 기능 외에 온보드 조명 이펙트도 갖추고 있습니다. 이러한 이펙트를 선택하려면 밝기 버튼을 누른 상태로 키보드 번호 키를 눌러 이펙트를 선택할 수 있습니다.

- |                               |                       |
|-------------------------------|-----------------------|
| • 밝기 + 키 1: 컬러웨이브(왼쪽에서 오른쪽으로) | • 밝기 + 키 7: 호흡        |
| • 밝기 + 키 2: 컬러웨이브(오른쪽에서 왼쪽으로) | • 밝기 + 키 8: 사용자 저장 조명 |
| • 밝기 + 키 3: 컬러웨이브(중앙에서 바깥쪽으로) | • 밝기 + 키 9: 사용자 저장 조명 |
| • 밝기 + 키 4: 컬러웨이브(아래에서 위로)    | • 밝기 + 키 0: 청록색       |
| • 밝기 + 키 5: 색 순환              | • 밝기 + 키 -: 이펙트 속도 감소 |
| • 밝기 + 키 6: 파동                | • 밝기 + 키 +: 이펙트 속도 증가 |

사용자 저장 이펙트는 G HUB 소프트웨어를 통해 키보드에 저장됩니다.

## 키보드 기능 - G 키

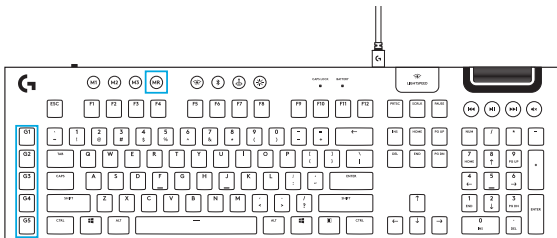

- 프로그래밍이 가능한 5개의 G 키 및 3개의 M 키는 게임별로 최대 15개의 고유한 기능을 제공합니다.
- 로지텍 G HUB 소프트웨어를 사용하여 G 키를 커스터마이징하십시오.
- 매크로를 기록하려면 다음을 수행하십시오.
  1. MR 키를 누릅니다.
  2. G 키를 누릅니다.
  3. 기록할 키를 입력합니다.
  4. MR 키를 누릅니다.
    - 동일한 G 키로 두 번째 매크로를 기록하려면 M2를 누르고 1-4 단계를 반복합니다.
    - 세 번째 매크로를 기록하려면 M3을 누르고 1-4 단계를 반복합니다.

로지텍 G HUB 소프트웨어를 [logitechG.com/GHUB](http://logitechG.com/GHUB)에서 다운로드하여 설치하십시오.



## 게임 모드 버튼



이 버튼은 표준 Windows 키 및 메뉴 키를 비활성화하여, 플레이에 방해가 될 수 있는 Windows 시작 메뉴가 게임 중에 활성화되지 않게 합니다. 게임 모드 중에는 게임 모드 LED가 켜집니다.

## 키보드 기능 — 백라이트



키보드 밝기 버튼을 이용하여 키보드 밝기를 조정합니다.

## 온보드 메모리



온보드 프로파일 3개를 G913에 저장할 수 있습니다. 프로파일은 G HUB 소프트웨어를 통해 G913에 다운로드되며, 키보드가 온보드 모드(G HUB 소프트웨어에서 선택하거나 G HUB 소프트웨어가 꺼져 있거나 설치되지 않은 경우)일 때 M1, M2 또는 M3를 선택하여 액세스합니다.

## 키보드 기능 – 미디어 컨트롤

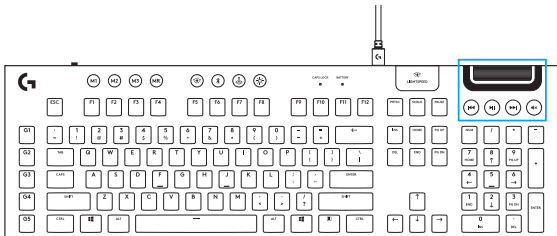

G913에는 키보드의 위쪽 모서리에 미디어 컨트롤 키가 있습니다.

- 볼륨 조절 롤러 – PC의 오디오 볼륨을 제어합니다.
- 이전 곡으로 이동 – 응용 프로그램에 따라 트랙의 시작점 또는 이전 트랙으로 이동합니다.
- 재생/일시정지 – 오디오 또는 비디오 재생을 시작하거나 중지합니다.
- 다음 곡으로 이동 – 응용 프로그램에 따라 트랙 끝 또는 다음 트랙으로 이동합니다.
- 음소거 – 오디오 출력을 중단합니다.

## 키보드 기능 – 배터리 표시기

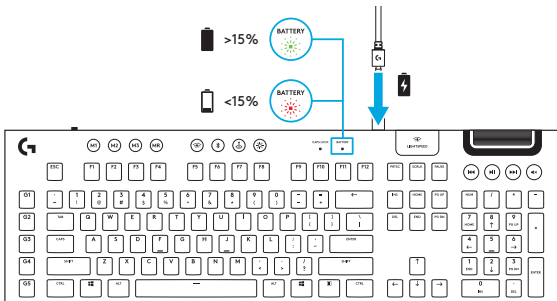

- 충전 중에는 녹색으로 깜빡입니다.
- 배터리가 15% 이상이면 가동 시 잠시 녹색으로 표시됩니다.
- 키보드를 충전해야 할 때는 빨간색으로 표시됩니다.

## 키보드 기능 — 무선 컨트롤

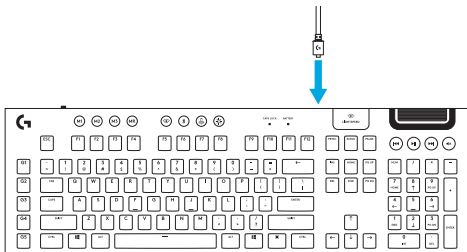
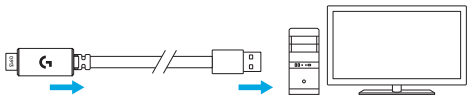

- LIGHTSPEED 버튼으로 LIGHTSPEED 무선 연결을 선택하고 동봉된 수신기 동글을 사용하여 PC 또는 Mac에 연결합니다. 무선 연결 시 흰색, 유선 연결 시 파란색으로 표시됩니다.

## 키보드 기능 - BLUETOOTH®

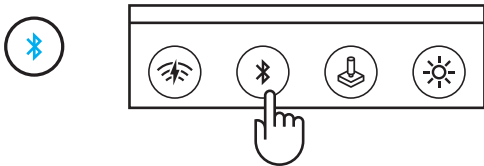

- Bluetooth 버튼을 장치와 Bluetooth 연결을 할 수 있습니다. 연결되면 파란색으로 표시됩니다.

## 키캡 제거 + 교체

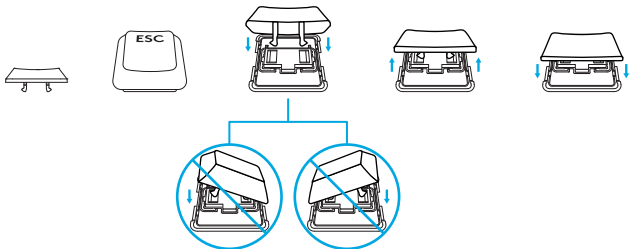

## 관리 및 청소

키보드를 청소하려면 보풀이 없는 극세사 패브릭을 사용하십시오. 젖은 천도 사용 가능합니다. 강한 세척제를 사용하지 마십시오.

키보드를 액체 안에 담그거나 흘리지 마십시오.

## LIGHTSPEED 連線

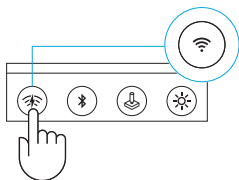
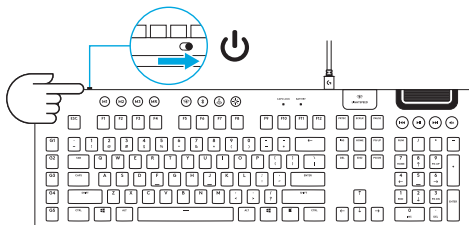
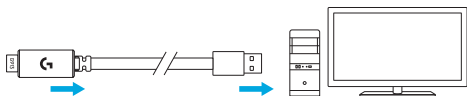

[www.logitech.com/support/G913](http://www.logitech.com/support/G913)

## 藍牙連接

1

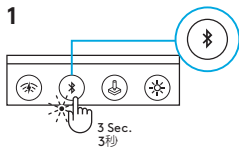

2



3



4

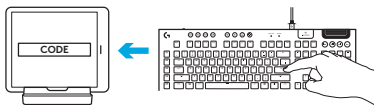



# 充電

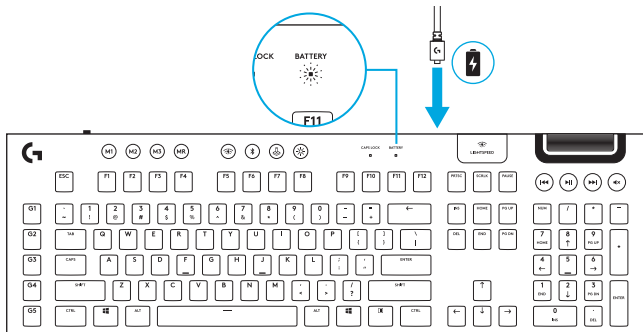

## 鍵盤功能

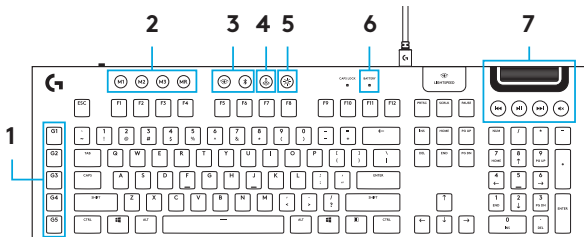

1. G 鍵
2. 模式切換
3. LIGHTSPEED 和 藍牙
4. 遊戲模式
5. 亮度
6. 電池指示燈
7. 媒體控制鍵

## 鍵盤功能 - 背光功能

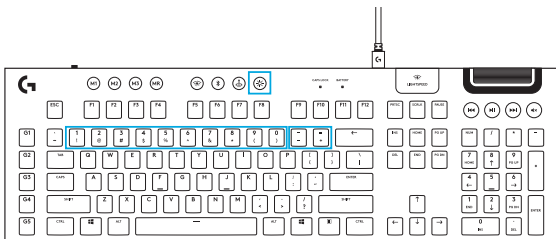

除了可透過 G HUB 軟體使用的燈光功能以外，G913 也有內建的背光效果。若要選擇這些效果，請同時按住亮度按鈕與鍵盤的數字鍵以選擇效果。

- 亮度 + 按鍵 1：色彩波浪 (由左到右)
- 亮度 + 按鍵 2：色彩波浪 (由右到左)
- 亮度 + 按鍵 3：色彩波浪 (由中心往外)
- 亮度 + 按鍵 4：色彩波浪 (由下往上)
- 亮度 + 按鍵 5：色彩循環
- 亮度 + 按鍵 6：漣漪
- 亮度 + 按鍵 7：呼吸效果
- 亮度 + 按鍵 8：使用者儲存的背光效果
- 亮度 + 按鍵 9：使用者儲存的背光效果
- 亮度 + 按鍵 0：青藍色
- 亮度 + - 按鍵：減慢效果速度
- 亮度 + + 按鍵：加快效果速度

使用者儲存的效果會透過 G HUB 軟體儲存到鍵盤。

## 鍵盤功能 - G-功能鍵

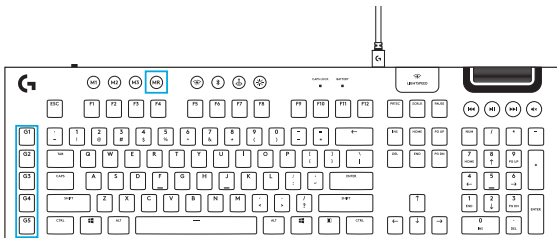

- 5 個可自訂的 G 功能鍵以及三個 M 鍵可為每個遊戲提供 15 種專屬功能。
- 可使用羅技 G HUB 軟體自訂 G 功能鍵。
- 若要紀錄巨集：
  1. 按下 MR 鍵。
  2. 按下 G 功能鍵。
  3. 鍵入要記錄的按鍵。
  4. 按下 MR 鍵。
    - 若要在同一個 G 功能鍵上記錄第二個巨集，請按下 M2 然後重複步驟 1-4。
    - 若要記錄第三個巨集，請按下 M3 然後重複步驟 1-4。

在下列網址下載並安裝羅技 G HUB 軟體：[logitechG.com/GHUB](http://logitechG.com/GHUB)

## 遊戲模式按鈕



此按鈕可停用標準 Windows 鍵與功能表鍵，以防止在遊戲中不慎啟動 Windows「開始」功能表而中斷遊戲。遊戲模式 LED 指示燈在遊戲模式下會亮起。

## 鍵盤背光



透過循環按下鍵盤亮度按鈕可調整鍵盤亮度。

## 內建記憶體



可以儲存三個內建記憶體到 G913 上。設定檔是透過 G HUB 軟體下載到 G913，並可在鍵盤處於內建記憶體模式時透過選擇 M1、M2 或 M3 來存取 (從 G HUB 軟體選取，或在 G HUB 軟體停用或未安裝時)。

## 鍵盤功能 - 媒體控制

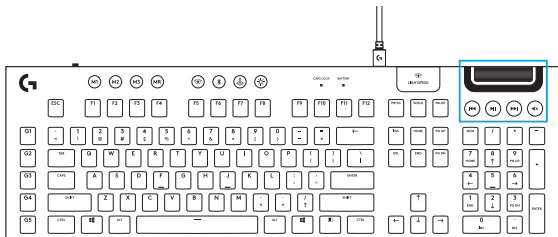

G913 擁有媒體控制功能，其位於鍵盤的右上角。

- 音量轉鈕 - 控制 PC 上啓用之音訊的音量。
- 向後快進 - 視應用程式而定，移到曲目開頭或上一曲目。
- 播放/暫停 - 開始或停止音訊或視訊播放。
- 向前快進 - 視應用程式而定，移到曲目末尾或下一曲目。
- 靜音 - 停止音訊輸出。

## 鍵盤功能 - 電池指示燈

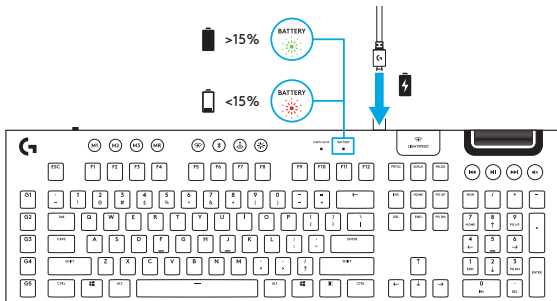

- 充電時會閃爍綠燈。
- 電池電量高於 15% 時，會於啟動時短暫亮起綠燈。
- 鍵盤需要充電時會亮起紅燈。

## 鍵盤功能 - 無線控制

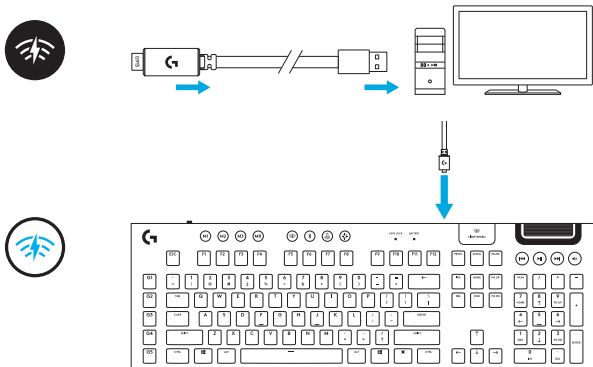

- LIGHTSPEED 按鈕可選擇 LIGHTSPEED 無線連線，這會使用隨附的接收器連接到 PC 或 Mac。連線建立時會亮起白燈，有線連線時會亮起綠燈。



## 鍵盤功能 - 藍牙

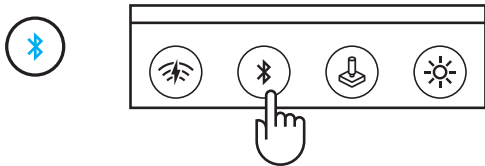

- 藍牙按鈕可用來透過藍牙功能連線到裝置。建立連線時會顯示藍燈。

## 鍵帽拔除 + 更換

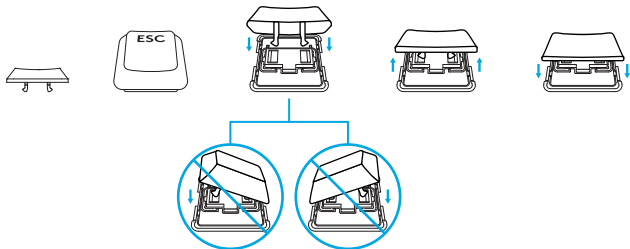

## 保養與清潔

若要清潔鍵盤，請使用柔軟的無絨或超細纖維布。可以使用濕布。切勿使用刺激性清潔劑。切勿將鍵盤浸入水中或接觸液體。



[logitechG.com/support/G913](https://logitechG.com/support/G913)

© 2019 Logitech, Logi and the Logitech Logo are trademarks or registered trademarks of Logitech Europe S.A. and/or its affiliates in the U.S. and other countries. Logitech assumes no responsibility for any errors that may appear in this manual. Information contained herein is subject to change without notice.  
版权所有 ©2019 年罗技。Logi、Logitech、罗技和罗技标志 Logitech Europe S.A. 和/或其美国及其他国家/地区附属公司的公司的商标，并或已注册。罗技对于本手册中可能出现的任何错误不承担任何责任。本手册中包含的信息如有更改，恕不事先通知。

WEB-621-001407.003

版權所有 © 2019 年羅技。Logi 和羅技標誌為 Logitech Europe S.A. 及/或其附屬公司在美國和其他國家的商標或註冊商標。羅技對於本手冊中可能出現的任何錯誤不承擔任何責任。本手冊中包含的資訊如有更改，恕不事先通知。

© 2019 Logitech, Logi 및 Logitech 로고는 미국과 기타 국가에서 Logitech Europe S.A. 및/또는 그 계열사의 상표 또는 등록 상표입니다. 로지텍은 이 설명서에 명시된 어떤 오류에 대해서도 책임지지 않습니다. 이 설명서에 있는 정보는 예고 없이 변경될 수 있습니다.